

Examen VMBO-KB

2024

versie rood, onderdeel C

profielmodule 3 – een product maken en verbeteren

profielvak-cspe D&P – KB

bijlage, variant b

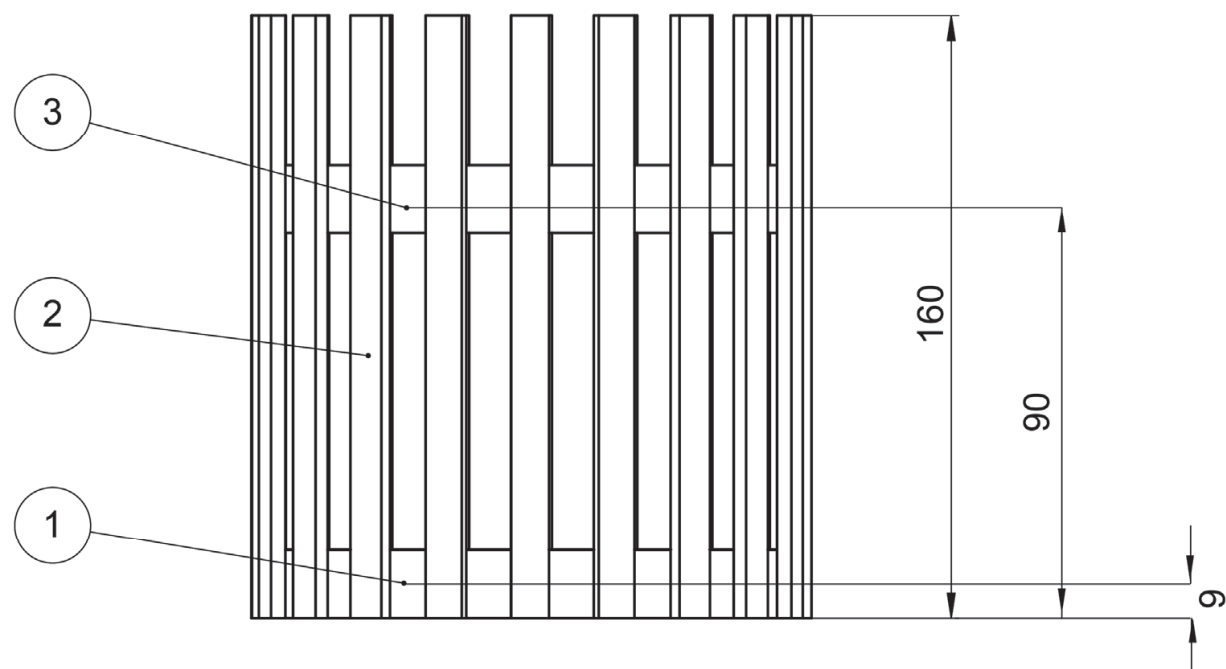
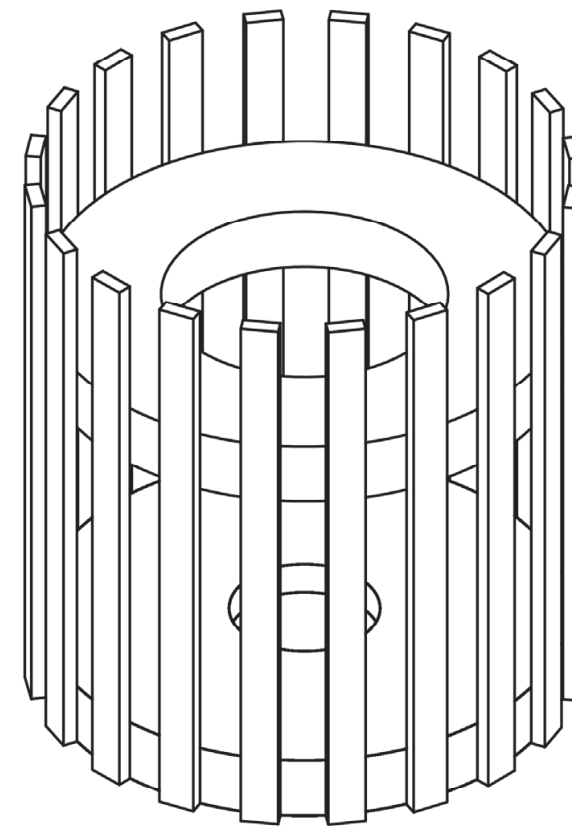
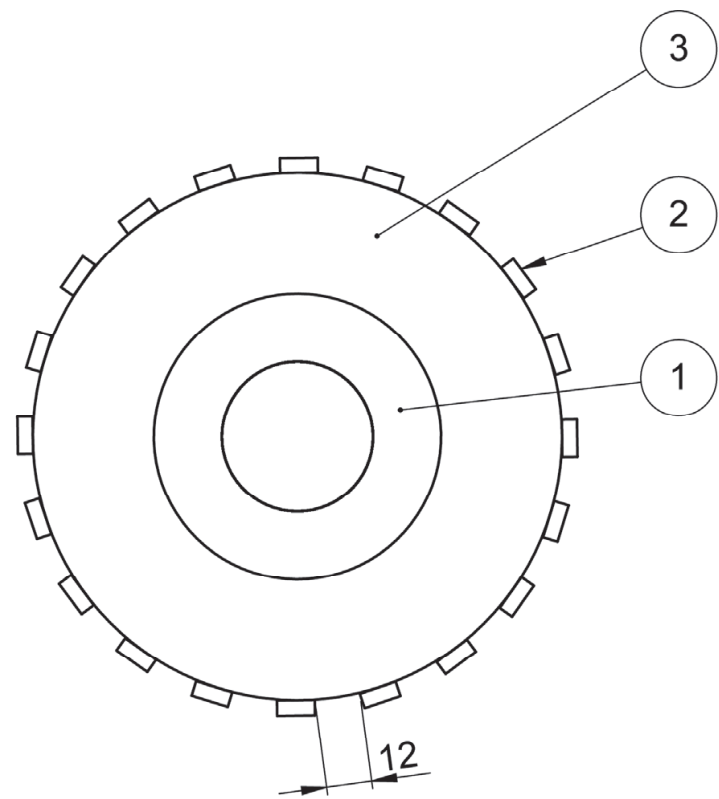

4	40	verloren-kopspijker	staal	Ø1,0 x 16-25	koopdeel	
3	1	topring	hout	Ø134 x 18	18 x 200 x 200	
2	20	lat	hout	160 x 9 x 4	900-3600 x 9 x 4	
1	1	bodemring	hout	Ø134 x 18	18 x 200 x 200	
STUK NR.	AANT.	BENAMING	MATERIAAL	NORMAANDUIDING OF AFMETING	OPMERKING	
			schaal 1 : 2 MAATEENHEID: mm DATUM: 2024	GETEKEND:HND AFDELING: D&P GEZIEN: --	Algemene tolerantie: - verspanend ± 0,5 mm - niet-verspanend ± 1 mm - hoeken ± 1°	
examen Rood		BENAMING: waxinelichthouder samenstelling			NUMMER: 01	FORMAAT: A3

3

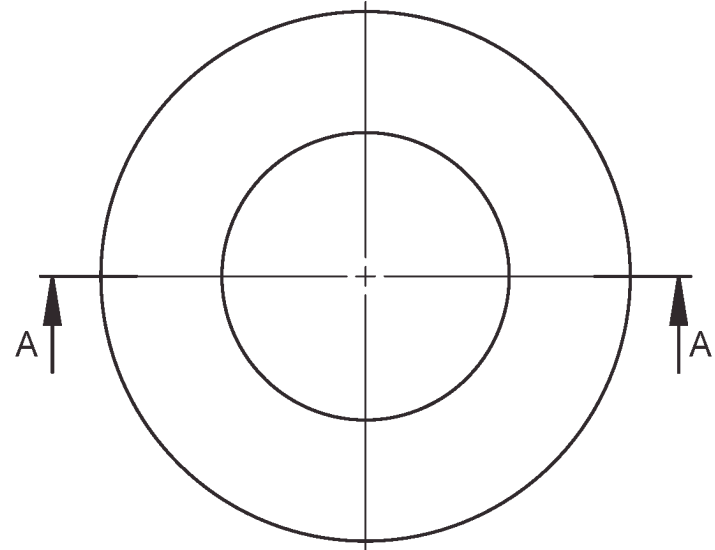

doorsnede A-A

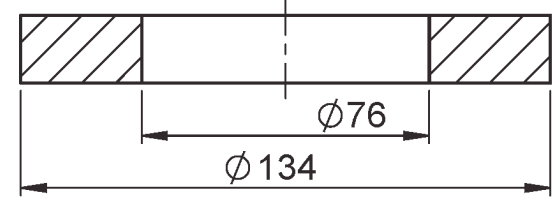

1

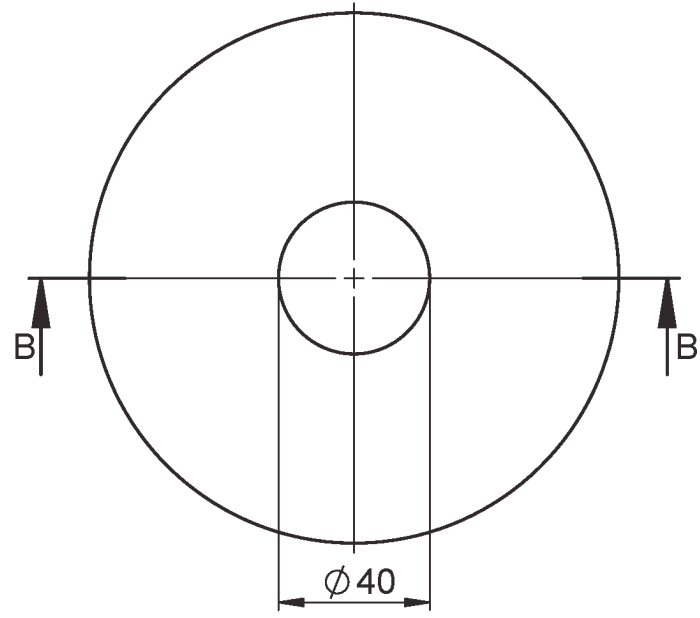

doorsnede B-B

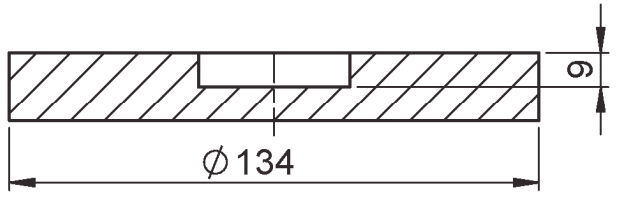

2

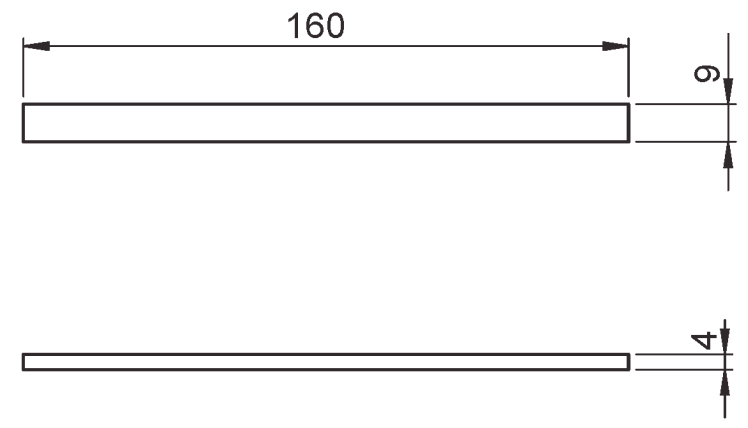

3	1	topring	hout	Ø134 x 18	18 x 200 x 200	
2	20	lat	hout	160 x 9 x 4	900-3600 x 9 x 4	
1	1	boderring	hout	Ø134 x 18	18 x 200 x 200	
STUK NR.	AANT.	BENAMING	MATERIAAL	NORMAANDUIDING OF AFMETING	OPMERKING	
			GETEKEND: HND		Algemene tolerantie: - verspanend ± 0,5 mm - niet-verspanend ± 1 mm - hoeken ± 1°	
			MAATEENHEID: mm	AFDELING: D&P		
			DATUM: 2024	GEZIEN: --		
examen Rood		BENAMING: onderdelen waxinelichthouder			NUMMER: 02	FORMAAT: A3