

onderdeel D

bijlage

opdracht 2 en 3

materiaalstaat boekentrap, alle maten zijn in mm:

trapboom:

omschrijving	aantal	materiaal	lengte	breedte	dikte
trapboom	2	grenen	1453	100	18

bovenste bakje:

omschrijving	aantal	materiaal	lengte	breedte	dikte
zijregel	2	grenen	200	55	18
achterregel	1	grenen	264	43	18
bodem	1	triplex	282	200	12

middelste bakje:

omschrijving	aantal	materiaal	lengte	breedte	dikte
zijregel	2	grenen	300	55	18
achterregel	1	grenen	282	43	18
bodem	1	triplex	282	300	12

koker:

omschrijving	aantal	materiaal	lengte	breedte	dikte
zijde	2	triplex	200	400	18
dek - bodem	2	triplex	300	400	18
HPL	1	HPL	410	310	0,8

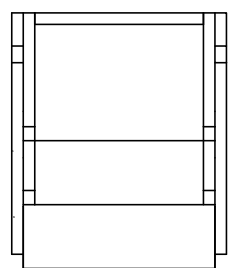

Bovenaanzicht

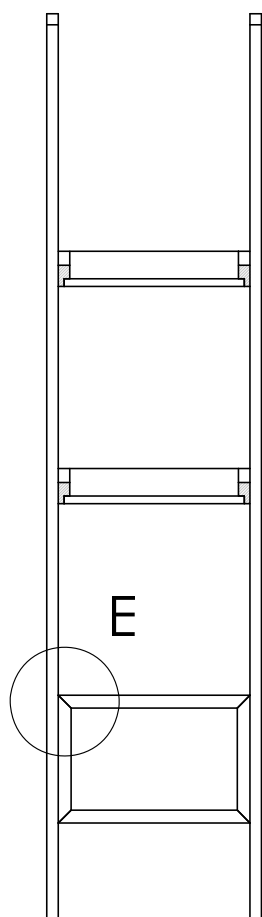

Vooraanzicht

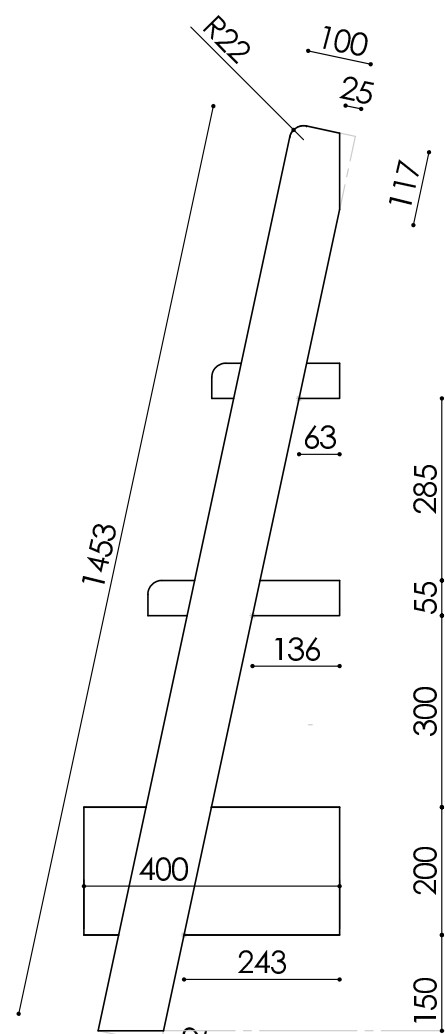

Rechterzijaanzicht

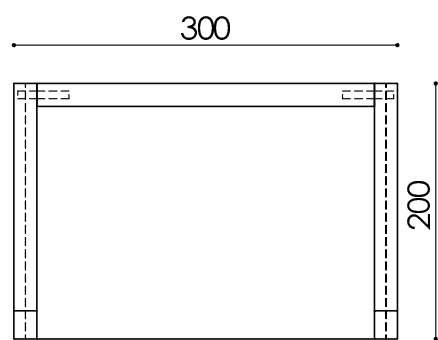

A Bovenaanzicht

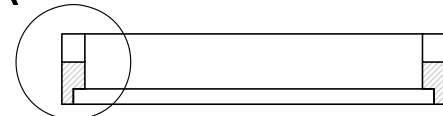

Vooraanzicht

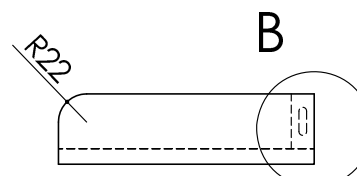

Rechterzijaanzicht

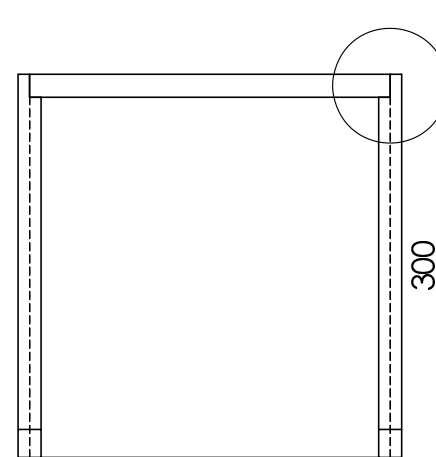

Bovenaanzicht

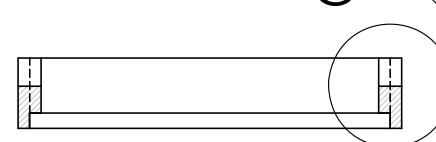

Vooraanzicht

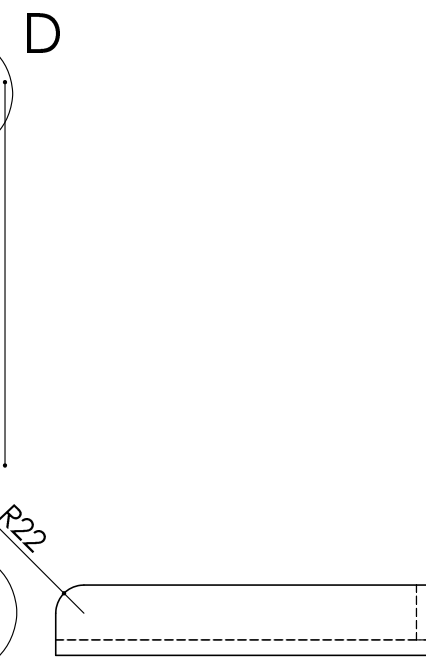

Rechterzijaanzicht

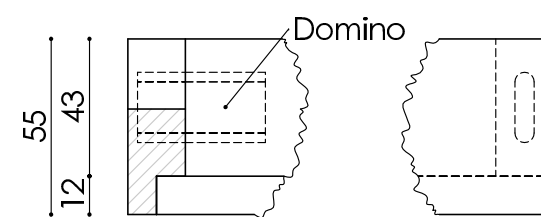

DETAIL A

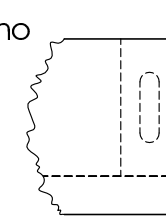

DETAIL B



DETAIL C

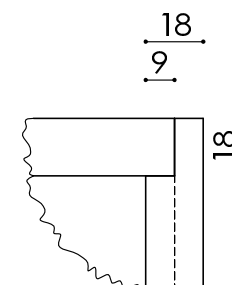

DETAIL D

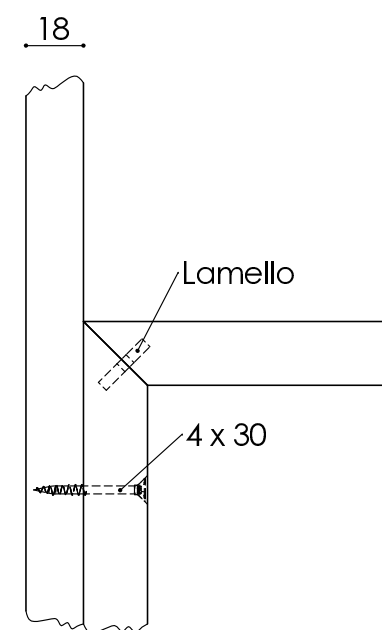

DETAIL E

**Renvooi.**

1. trapbomen en zijkanten bakjes uitgevoerd in grenenhout
2. koker en bodem bakjes uitgevoerd in triplex 18-12 mm
3. lijm de verbindingen
4. bovenzijde koker beplakken met HPL
5. de bakjes en de koker worden vanaf de binnenzijde vastgeschroefd aan de trapboom

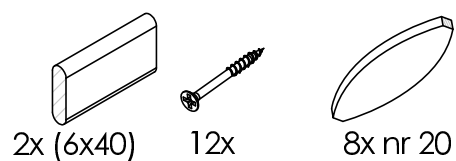

**Boekentrap BB**